

# K-STYLE GUTTER + ACCESSORIES

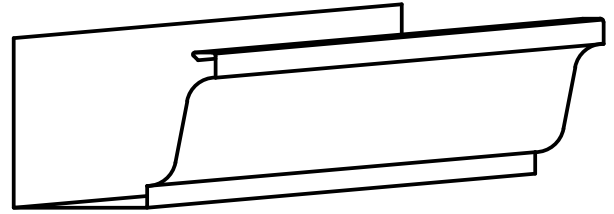

## STAMPED HIDDEN HANGERS

## GUTTER SUPPORT BRACKETS

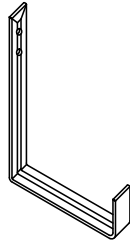
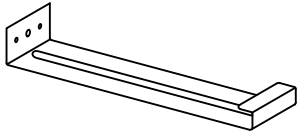

## SPLICE PLATES

## END CAPS

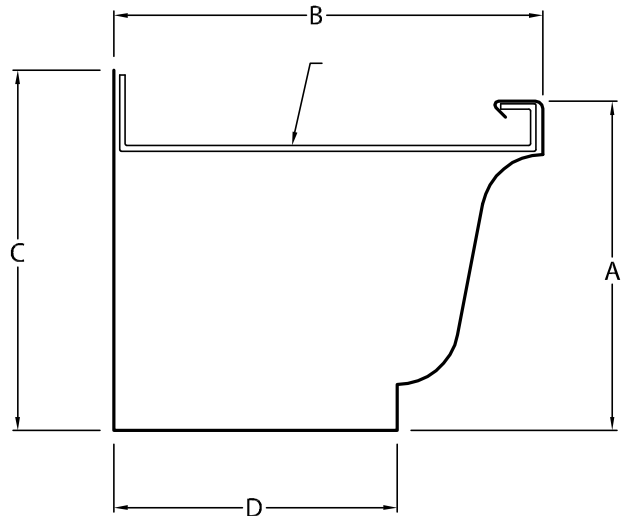
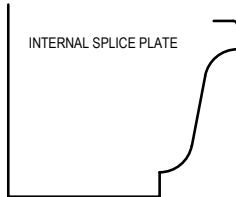
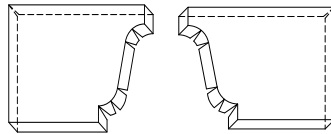
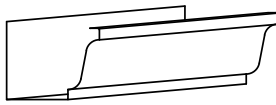

SIZE:	A	B	C	D
<input type="checkbox"/> 5"	3 <sup>13</sup> / <sub>32</sub> "	5"	3 <sup>13</sup> / <sub>16</sub> "	3 <sup>1</sup> / <sub>4</sub> "
<input type="checkbox"/> 6"	4 <sup>1</sup> / <sub>2</sub> "	6"	5"	3 <sup>7</sup> / <sub>8</sub> "
<input type="checkbox"/> 7"	5 <sup>3</sup> / <sub>8</sub> "	7"	5 <sup>7</sup> / <sub>8</sub> "	4 <sup>5</sup> / <sub>8</sub> "
<input type="checkbox"/> 8"	6"	8"	6 <sup>1</sup> / <sub>8</sub> "	5 <sup>3</sup> / <sub>8</sub> "
<input type="checkbox"/> 9"	7 <sup>1</sup> / <sub>2</sub> "	9"	8"	6 <sup>3</sup> / <sub>4</sub> "
<input type="checkbox"/> 10"	8 <sup>1</sup> / <sub>2</sub> "	10"	9"	7 <sup>3</sup> / <sub>4</sub> "
<input type="checkbox"/> 11"	9 <sup>1</sup> / <sub>2</sub> "	11"	10"	8 <sup>3</sup> / <sub>4</sub> "

## MATERIAL:

22GA STEEL  
24GA STEEL  
26GA STEEL (limited color availability)

22GA STAINLESS STEEL  
24GA STAINLESS STEEL  
26GA STAINLESS STEEL

.032 ALUMINUM  
.040 ALUMINUM  
.050 ALUMINUM  
.063 ALUMINUM

16OZ COPPER  
20OZ COPPER

## COLOR:

## NOTES:

- Subject to minimum requirements
- Custom lengths available

## QUANTITIES:

\_\_\_\_\_ LINEAL FEET@ 10'-0" LENGTHS ②  
\_\_\_\_\_ LINEAL FEET@ 20'-0" LENGTHS ① ②  
\_\_\_\_\_ OUTSIDE MITERS@ 90°  
\_\_\_\_\_ INSIDE MITERS@ 90°  
\_\_\_\_\_ ENDCAPS: RIGHT \_\_\_\_\_ LEFT \_\_\_\_\_  
\_\_\_\_\_ SPLICE PLATES  
\_\_\_\_\_ EXPANSION JOINTS  
\_\_\_\_\_ HIDDEN HANGERS  
\_\_\_\_\_ GUTTER SUPPORT BRACKETS

## PRINT APPROVED BY:

\_\_\_\_\_  
(SIGNATURE) (DATE)

A SIGNED PRINT APPROVAL SIGNIFIES A CUSTOMER HAS VERIFIED ALL DIMENSIONS, SIZES, QUANTITIES, AND MATERIAL TYPES.

FABRICATION WILL PROCEED ONLY AFTER RECEIPT OF SIGNED PRINT APPROVAL

## PROJECT INFORMATION

\_\_\_\_\_  
(PROJECT NAME)

\_\_\_\_\_  
(ARCHITECT)

\_\_\_\_\_  
(CUSTOMER)

\_\_\_\_\_  
(REPRESENTATIVE/ DISTRIBUTOR)

Roof Drainage Components & Accessories, Inc

60 Don Wesbrook Ave North  
Jasper, GA 30143

706-692-7333

sheffield@rdcaa.com

www.rdcaa.com